



Safety for Industrial Process

USER MANUAL
PRESSURE SWITCHES
AND TEMPERATURE SWITCHES
F-FP-FX Series



www.georgin.com

I.	Introduction	3
1.	Purpose	3
2.	Operating principle	3
3.	Pressure Equipment Directive (PED)	3
4.	General information on electric functions	4
II.	Before installation	5
III.	Recommendations and prohibitions	6
1.	General Recommendations	6
2.	Specific recommendations	7
3.	Prohibited actions	8
4.	Requirements	8
IV.	Commissioning	9
1.	Fixing	9
2.	Mounting	10
V.	Adjustment	12
1.	Selection guide	12
2.	Equipment required	13
3.	Pre-adjustment operations (for any type of adjustment)	13
4.	Type A adjustment: fixed dead band instrument	14
4.1.	PROCEDURE A1: SINGLE INSTRUMENT	14
4.2.	PROCEDURE A2: DIAPHRAGM-ACTUATED DIFFERENTIAL INSTRUMENT	15
4.3.	PROCEDURE A3: BELLOWS-ACTUATED DIFFERENTIAL INSTRUMENT	15
5.	Type B adjustment: adjustable dead band instrument	16
5.1.	PROCEDURE B1: SINGLE INSTRUMENT	16
5.2.	PROCEDURE B2: DIAPHRAGM-ACTUATED DIFFERENTIAL INSTRUMENT	17
5.3.	PROCEDURE B3: BELLOWS-ACTUATED DIFFERENTIAL INSTRUMENT	17
6.	Type C adjustment: instrument with two offset switches	18
6.1.	PROCEDURE C1 : SINGLE INSTRUMENT	18
6.2.	PROCEDURE C2: DIAPHRAGM-ACTUATED DIFFERENTIAL INSTRUMENT	19
6.3.	PROCEDURE C3: BELLOWS-ACTUATED DIFFERENTIAL INSTRUMENT	19
VI.	Wiring	20
1.	The electrical switch	20
2.	Cable entries	20
3.	Internal terminal blocks	20
4.	Breaking capacity (resistive circuits)	21
5.	The pneumatic switch	21
VII.	Maintenance	22
1.	Inspection frequency	22
2.	Precautions to take during maintenance	23

I. Introduction

You have just purchased a GEORGIN instrument that has undergone extensive testing and several quality checks to ensure your complete satisfaction. Appropriate specification, according to your process, and compliance with the instructions in this manual will ensure an optimum working life for your instrument.

1. Purpose

F Series instruments are intended for process monitoring. This manual gives the assembly and adjustment instructions to be applied for optimum operation of your instrument. You must read and obey these instructions when installing your instrument.



Never tamper with components of the instrument that are sealed with red varnish. Any damage caused by a failure to follow these instructions will invalidate the manufacturer's guarantee.

2. Operating principle

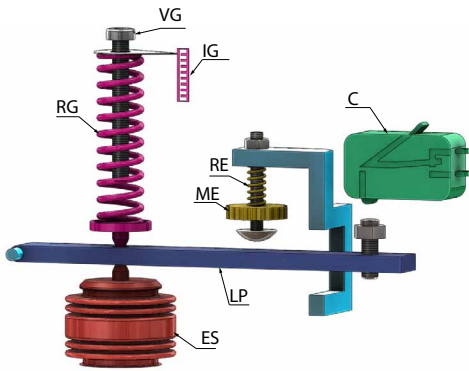

- VG: Range adjustment screw
- RG: Range spring
- IG: Range index
- RE: Dead band adjustment and offset spring
- ME: Dead band adjustment and offset knob
- ES: Sensing element
- LP: Flexible arm
- C: Switch

The pressure or temperature is applied to the sensing element (ES), whose position then changes, acting on the flexible arm (LP). The force produced in this way is balanced by the spring (RG). This is how the set point is adjusted. As the set point is approached, the change in forces disturbs the balance and acts on the contact.

A second spring (RE) acting on the end of the flexible arm (LP) increases the deviation of the switch(es). The force produced by the dead band spring is adjustable, and is used to offset the two contacts in the case of differential functions.

NOTE: The pressure switch and temperature switch scales indicated in our catalogue are values for a set point to lower the pressure or temperature.

3. Pressure Equipment Directive (PED)

F series pressure and temperature switches satisfy the requirements set forth in Appendix I of PED 2014/68/EU. They are classified in Category IV as a safety accessory, and can be incorporated in a safety loop. Refer to our declaration of compliance for the models concerned and conditions of use.

4. General information on electric functions

The instruments may be equipped with electrical or pneumatic functions.

4.1. Electrical functions

Note:

The dead band values given in our catalogues are indicative values recorded in a laboratory, measured between the maximum and minimum settings. If the instrument is used outside its operating limits, the set point(s) and dead band values may be affected.

The electrical function of the instrument differs according to the type of microswitch used. Many different versions are on offer (gold-plated, tropicalised, nitrogen sealed, etc.).

4.1.1. Single fixed dead band electrical function:

Microswitch "only". Each type of microswitch has its own characteristics, as indicated in the catalogue.

Models: 4, 4D, 10, 10D, 16, 16D, 60, 60C, ...

4.1.2. Single adjustable dead band electrical function:

Microswitch combined with a spring (RE) to increase the microswitch dead band value in a given range (refer to the dead band table in the catalogue)

The trigger value of the upper threshold can be offset using the RE spring.

This action has no effect on the lower threshold.

Models: 6, 6D, 6V, 96, 62, 62C, ...

4.1.3. Electrical function with two simultaneous contacts:

Combination of two single functions set to act at the same time, either upwards or downwards. The dead band of a simultaneous function is greater than that of a single function. When rolling out from the factory, the simultaneity is wedged to the decrease of pressure / temperature.

Fixed dead band models: 44, 30, 36, 160, 160C, ...

Adjustable dead band models: 34, 34V, 106, 162, 162C, ...

4.1.4. Electrical function with two offset switches:

Combination of two single functions adjusted to act with a gap between. The spring (RE) is used to adjust the gap between the interlocking of the switches.

Models: 54, 54D, 54V, 50, 56, 116, 170, 170C, 172, 172C, ...



For temperature switches, the minimum dead bands given in our manuals are recorded under ideal test conditions. The sensing element experiences the temperature variations of the installation without delay and in its bulk. In operation, these dead bands can be different in view of the exchange conditions: rate of temperature change, specific heat, radiation, inertia of the measuring instrument compared to inertia of temperature switch, presence of a sleeve or thermowell, etc.

4.2. Pneumatic functions

The instruments can be equipped with one or more Normally Open (NO) or Normally Closed (NC) pneumatic functions using a poppet or spool valve.

Georgin offers single, simultaneous double, and offset double pneumatic functions.

The supply connections are M5, 1/4, or 1/8 gas threaded according to the type of function or the model.

According to the type of cell, the control pressure will be:

- As standard: 1.5 to 8 bar (poppet design <> with a residual leak).
- On request: 0 to 10 bar (spool design <> without leak).

The control fluid must be compatible with the ISO-VG 10 standard (air, nitrogen, etc.).

Maximum allowable filtration 5 µm.

The standard materials for the cell body are polyamide, brass, and/or aluminium. The seals are made of NBR (other types on request).

II. Before installation

The pressure switch or temperature switch must be stored in a sheltered location, in its original packaging.

The storage temperature must be between:

- 40 and +70°C for bellows instruments
- 20 and +70°C for diaphragm pressure switches
- 40 and +55°C for temperature switches from the C and G ranges
- 40 and +50°C for temperature switches from the B ranges

They must not be stacked to reach a load greater than 10 kg.

Allow the instrument to return to ambient operating temperature before installing it.

Whilst removing the packaging, check the equipment and all accessories.

The housing must be examined to check the following points:

- Check that the paint has not been damaged.
- Check that there are no signs of deformation or impact on the housing.

Before installation check again that the materials in contact are compatible with the process to be monitored. If necessary, protect the instrument with a safety device that is appropriate to the application (pressure limiter, shock absorber, etc.).

For instruments equipped with an clamping screw for transport (located in the instrument's process connection), remove this item.

For FML/DFML instruments

1. Loosen the locknut and the clamping screw inserted in the connection.
2. Connect the instrument to a pressure bench on the HP side, and apply a pressure of 150 mbar. Return to atmospheric pressure, and disconnect the instrument from the bench.
3. Rest the instrument for 24 hours before calibrating.

III. Recommendations and prohibitions

1. General Recommendations

1.1. Operating temperature limits (pressure sensing element)

Bronze bellows:	-20 to +60°C
Stainless steel bellows:	-20 to +150°C
Stainless steel tube:	-20 to +150°C
NBR diaphragm:	-20 to +100°C
EP diaphragm:	-40 to +120°C
FKM diaphragm:	0 to +150°C

⚠ For temperature switches, refer to the range tables. ⚠

1.2. Ambient operating temperature limits (housing)

-20 to +70°C - others on request.

For temperature switches from the C and G ranges: max. 55°C. B range: max. 50°C.

1.3. Radiant heat

Avoid installing the instrument near (radiant) heat sources. Observe the ambient operating temperature limit.

1.4. Pulsations

A suitable damper or capillary must be provided to protect bellows instruments in case of pulsations or process instability (possible use of PA-type pressure switches).

1.5. Steam

A siphon must be placed upstream from the pressure switches on a steam circuit to limit the temperature at the sensor.

1.6. Condensation

Protect from excessive sunlight to limit the effects of night-time condensation. The installation location must be chosen very carefully in seaside locations or damp environments.

1.7. Vibrations

Avoid mounting the instrument directly on vibrating equipment. Choose a location that shelters the instrument from vibration as much as possible. Flexible piping connections and silent blocks may sometimes be necessary.

1.8. Mounting the housing (see Chapter IV.1)

Georgin recommends mounting the housing in accordance with the following rules:

- a. For bellows or Bourdon tube pressure switches and temperature switches:

The orientation of the housing has little effect on the operation of the instrument, but an upright (vertical) position is nevertheless recommended (with adjustment screw facing upwards). This prevents premature wear and preserves the measurement characteristics.

- b. For diaphragm pressure switches:

Diaphragm instruments (except FPA type) **MUST** be mounted vertically (with adjustment screw facing upwards), with the diaphragm horizontal, on an appropriate mounting bracket.

Because of the weight and/or the shape of the sensing element, the housing of these instruments must **NEVER** be used as a mount.

1.9. Installation (see Section IV.2)

The instruments are mounted according to type. Refer to the specific dimensional drawings.

For pressure switches, if the pressure connection uses a rigid tube, ensure that this tube is aligned with the axis of the connection so that the housing, and the measuring element in particular, are not subject to any mechanical loads that could deform them or shift the threshold.

2. Specific recommendations

2.1. ATEX devices

For ATEX devices, it is **ESSENTIAL** to refer to the "ATEX Instruction Manual" supplied with the equipment and available on www.georgin.com.

2.2. Low- and medium-pressure instruments

Diaphragm-actuated instruments (except FPA type) **must** be installed with the diaphragm horizontal and secured to a special mounting bracket.

Ask us for further information.

2.3. Differential pressure switches

To ensure that the contact(s) will change state, the pressure in the HP chamber must be greater than that in the LP chamber. This difference must be greater than the sum of differential pressure (ΔP) + microswitch dead band

$$HP - LP > \Delta P + e$$

Type	Scale ΔP	Adjustable dead band \leq		Max. dead band \geq	Max. P static Min / Max
		1x SPDT	2x SPDT		
	bar	96	106	bar	bar
FD.PX	0.5 to 10	0.43	0.7	2	0.5 / 13

Example : For an FD.PX in function 96, the pressure in the HP chamber must be greater than the pressure in the LP chamber by at least:

- P. HP – P. BP > 0.5 + 0.43 bar
- P. HP – P. BP > 0.93 bar

2.4. Bourdon tube instruments (FPL sensors)

When the instrument is mounted on 'rigid' fittings, ensure that the mount does not apply any residual loads to the process connector.

2.5. Temperature switches

Any difference in level between the housing and the probe must be taken into account. Where necessary, to inhibit the effect of the height of the liquid column, the calibration values may need to be corrected.

Ask our technical department to help determine the correction values.

3. Prohibited actions

3.1. Integrity of the housing

To avoid compromising the mechanical properties of the enclosure and invalidating its qualification level, no drilling or machining must be performed on these measuring instruments.

Gas throttling surfaces (seal planes) are kept clean, lightly lubricated (e.g. silicone grease) and free of dents or scratches.

Add-on seals and paint are strictly prohibited.

4. Requirements

4.1. Temperature switches

4.1.1. Devices equipped with a thermowell

For bulbs implanted in **thermowells** (except perforated thermowells) for gaseous fluid applications, a thermal bridge must be created between the bulb and the thermowell using a filler liquid (oil) or a heat-conducting paste.

⚠ Caution: Ensure that the quantity of liquid or paste is not excessive, to avoid compressing the bulb, but is sufficient to cover it completely. **⚠**

4.1.2. Orientation of the probe

ESSENTIAL: Thermostatic probes must be installed facing down, with the capillary outlet at the top.

The measurement probe must not be placed in a horizontal position.* Our temperature switches consist of two main components: probe and housing, which might or might not be connected by a capillary.

The position of the probe can affect the operation of the temperature switch. This type of probe is intended for vertical use, and is placed lower than the housing.

Any deviation from these conditions can affect the response time and operation of the device.

Our temperature switches are built with a filling that allows the probe to be tilted 45° without affecting their operation. Beyond that, their operation depends on the value of the measured temperature compared to the ambient temperature.



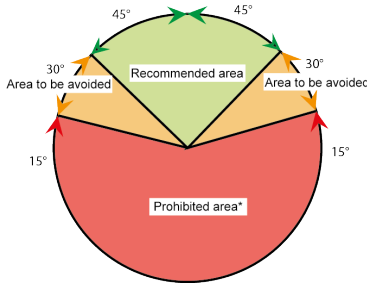

Recommended area :

±45° either side of the vertical axis, bulb down (capillary output up).

Area to be avoided :

from 45° to 75°, the operation of the sensor depends on the measured temperature value (Ts) and the ambient temperature (Ta):

Ta > Ts: operation is not affected,

Ta < Ts: operation might be affected,

Ta = Ts: operation is affected.

***Prohibited area**

Beyond 75°, the operation of the sensor can be significantly affected. This is difficult to predict and depends on several physical parameters.

Technical solutions are possible on request (ask us).

IV. Commissioning

1. Fixing

1.1. Bellows, Bourdon tube, and FPA diaphragm pressure switches, and temperature switches

- Secure the two mounting tabs to the housing using the M5 screws (2.5 Nm)
Georgin recommends using strong thread locking compound.
- The cover must be closed using the four captive screws (1.2 Nm).

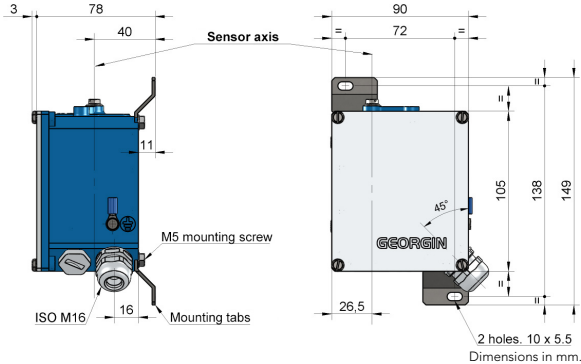

Standard housings are supplied with special plates for FD (H) and FV (drawings available on request) For the FP (polyester housing) and FX (stainless steel housing) series instruments, the dimensional drawings are available on request..

1.2. Diaphragm pressure switches (except FPA type)

These instruments are supplied without a wall mounting plate. Use the following mounting methods:

- (D)FML : Use the four spacers provided around the edge of the sensing element.
- (D)FMS: Use the four M6 threads provided under the sensing element.
- (D)FMT: Use the four M8 threads provided under the sensing element.

We provide special angle brackets for the purpose. Ask Georgin for further information.

1.3. 2" pipe mounting kit

The mounting schemes can be downloaded at http://www.georgin.com/pdffiles/fu-mounting_kit-fren.pdf

2. Mounting



Avoid mounting on a vibrating wall. This may result in a premature electrical malfunction.

It is especially when approaching the changeover thresholds that our devices are particularly sensitive to certain vibration frequencies.

If no other mounting is possible, we recommend the use of elastic suspensions for any use on a vibrating wall, especially in the case of a slow evolution of the pressure or temperature.

2.2. Pressure switch mounting

The instruments are equipped with a 1/2" GM or 1/4" GF (to ISO 228-1) connection as standard.

Other connections on request (NPT connection to ASA B2-1).

Optional welded connection (see fc-a3500-fren).

To make the connections, use the appropriate spanners for the connections, and never use the housing to tighten. Recommended tightening torque on the pressure connection: 50 N·m for the 1/2" GM.

Check that the pressure inlet tubes are not applying any mechanical load to the connection and the housing.

Observe the environmental and fluid-related conditions corresponding to the characteristics of the instruments. Provide tubing or a capillary to avoid any overheating through conduction.

Never exceed the maximum pressure of the instrument indicated on the label on the side of the housing.

2.2.1. Monitoring liquid pressure:

The pressure switch must be installed under the pressure tapping.

The pipework must be installed in a way that prevents any accumulation of gas in the pressure switch.

The installation of a gas collection tank is recommended.

The pipes connecting the process to the pressure switch must have a descending slope of at least 1/10 to prevent gas accumulation.

2.2.2. Monitoring gas pressure:

The pressure switch must be installed above the pipes to prevent condensation in the connection pipes and the measurement chambers.

If the gas temperature is high, a cooler or a siphon may be used.

The pipes connecting the process to the pressure switch must have a rising slope of at least 1/10 to prevent the accumulation of liquid or condensates.

2.2.3. Monitoring the vapour pressure:

The pressure switch may be installed laterally or under the pressure tapping.

A condensate vessel must be installed between the pressure switch and the pressure connection.

The pipe or gauge siphon (see fc-a3000-fren) connecting the condensate vessel to the pressure switch must be filled with water beforehand.

A bleeder valve must be installed.

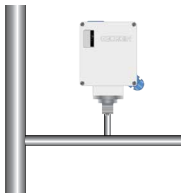

Lateral installation



Installation under the pressure fitting

2.3. Temperature switch mounting

Observe the environmental and fluid-related conditions corresponding to the characteristics of the instruments. Never exceed the maximum temperature of the instrument indicated on the label on the side of the housing. A capillary introduced into the liquid can be of any length.

2.3.1. Direct probe device (Type FB) :

Secure the instrument via its connection (on G 3/8" thread as standard, other on request). Completely immerse the probe.

2.3.2. Ambient monitoring instrument (Type FBA) :

The instrument must be installed in a well ventilated location, away from heat sources or refrigerant devices. It must not be subjected to sudden temperature changes.

For monitoring in inhabited buildings, install the temperature switch 1.50 m above the floor and far from external walls.

2.3.3. Remote probe device (Type FC) :

Do not constrain the capillary. It must remain flexible to transmit the signal.

Roll the capillary with a diameter of at least 80 mm.

NOTE: In certain cases, the size of the bulb and the length of the capillary can be specified in the order.

a. Monitoring fluids

Completely immerse the probe.

Use an appropriate type GBX or GCX immersion sleeve immersed perpendicular to the flow, or use a PC(X)**(B) capillary cable gland according to the existing process fitting type.

b. Monitoring surfaces

Carefully clean the contact surface and the probe.

Secure the probe using a metal (preferably cuprous) collar, covering the length of the probe.

Add thermal insulation on top.

Take care to observe the probe orientation (see Chapter III - 4..1.2)

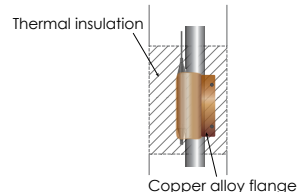

2.3.4. Accessories :

Capillary cable gland kit:

If the capillary outlet must be tight, use our special PC(X) type cable gland.

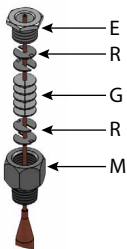

- Slide nut E onto the capillary.
 - Secure sleeve M on the thread (1/2" GF, NPTF, etc.).
 - Insert two washers R in sleeve M, inverting the notches.
 - Insert gasket G, consisting of five (or six, according to model) Teflon washers.
 - Insert the other two washers R like the first two.
 - Tighten nut E onto sleeve M.
- For further information, ask us.

V. Adjustment

The adjustment procedures vary from one instrument to another. An instrument is adjusted according to several criteria.

1. Selection guide

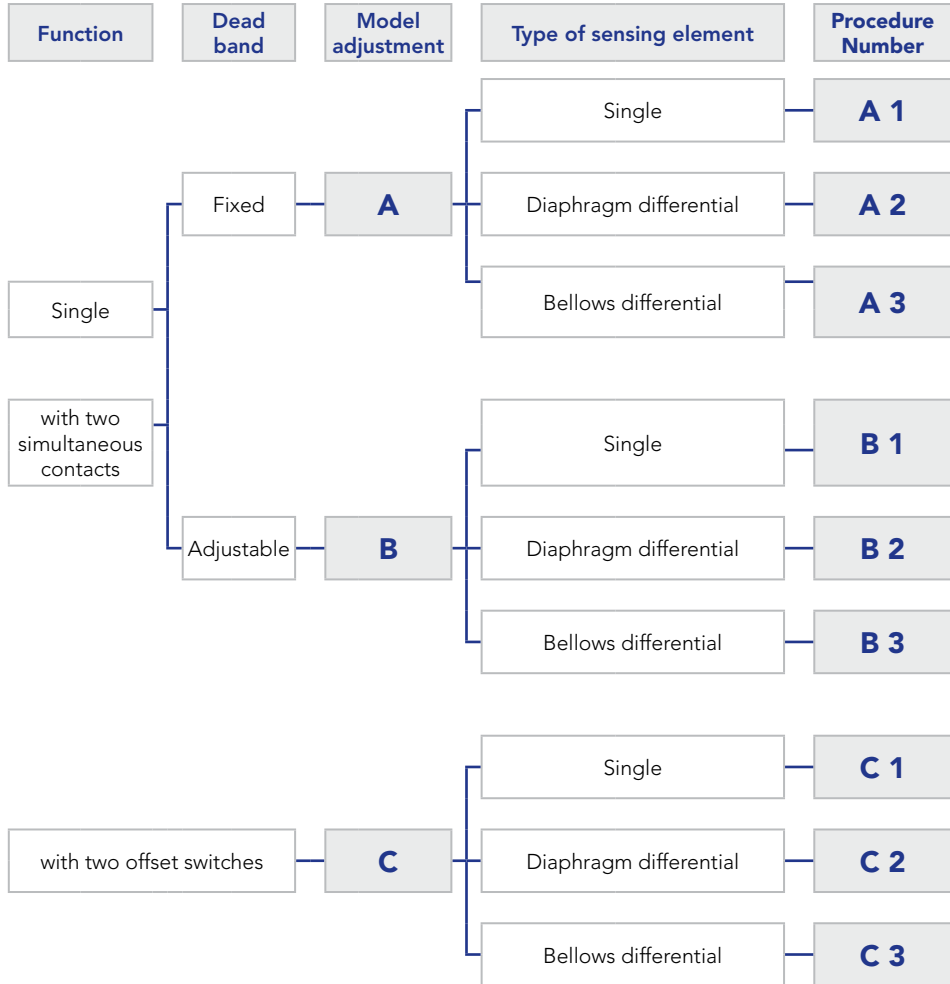

Note : Instruments equipped with two simultaneous contacts are adjusted in the same way as devices with a single electrical function.

It is impossible to guarantee that the contacts of bipolar devices will close absolutely simultaneously on the upper and lower points. If that condition is required, choose a unipolar regulator controlling a bipolar relay. If the device is not factory calibrated, simultaneity will be achieved on the drop in pressure or temperature. The values of the upper and lower points are modified by operating adjustment screw VG. Operating the dead band adjustment and offset knob MR only varies the highest point or the dead band. The identification plates are engraved to show both metric and Imperial units.

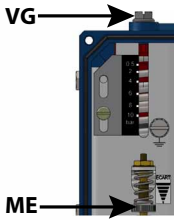

Clockwise:

Lowers the set point and/or dead band value.



Anticlockwise:

Increases the set point and/or dead band value.

2. Equipment required

- » A 1% class calibration standard:
 - For pressure switches: a pressure gauge
 - For temperature switches: a thermometer
- » A pressure or temperature generator:
 - For pressure switches: an air generator for pressures from -1 to 80 bar; Hydraulic for pressures from 80 to 1000 bar
 - For temperature switches: a thermostatic bath
The coolant fluid must be appropriate for the temperatures concerned (e.g. water-glycol from -20 to 0°C).
- » An electric low level system (1 ohmmeter + 1 buzzer + indicator light) - powered at 24 V ≈.

3. Pre-adjustment operations (for any type of adjustment)

- » Loosen the four captive screws holding the cover, and then remove it. Perform a visual inspection of the instrument.
- » Install the instruments:
 - For pressure switches: connect the instrument to a pressure bench
 - For temperature switches: immerse the bulb(s) in the bath
- » The range (RG) and dead band (RE) springs, if the instrument has any, must be completely relaxed.
- » Connect the terminal(s) to the electrical system.

For pressure switches, the pressure change when approaching the thresholds will be approximately:

- » For a threshold < 2.5 mbar: ≤ 0.025 mbar/min
- » For a threshold < 10 mbar: ≤ 2.5 mbar/min
- » For a threshold < 100 mbar: ≤ 3.5 mbar/min
- » For a threshold > 100 mbar: $\leq 5\%$ measuring range/min

For temperature switches, the temperature change will be approximately 0.5°C/min.

Note: The following procedures describe the steps to be applied in order to calibrate pressure switches.

For temperature switches, the procedure is the same as for single or differential bellows-actuated pressure switches:

- Adjust in °C
- Vary the temperature

4. Type A adjustment: fixed dead band instrument

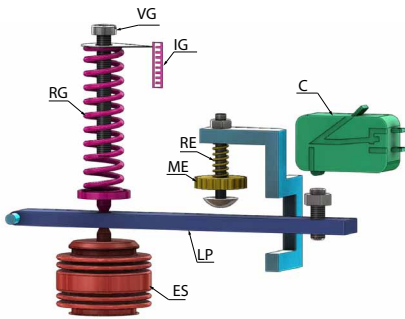
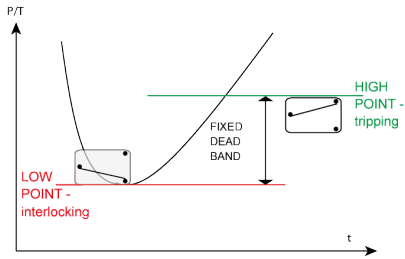

- VG: Range adjustment screw
- RG: Range spring
- IG: Range index
- RE: Dead band adjustment and offset spring
- ME: Dead band adjustment and offset knob
- ES: Sensing element
- LP: Flexible arm
- C: Switch

4.1. Procedure A1: Single instrument

Example: 6-bar rising setting

4.1.1. Adjusting the set point

1. Raise the pressure to the threshold (6 bar) and stabilise it.
2. Using set point adjustment screw VG, relax range spring RG until switch(es) C changes state.
3. Retighten and stop at the exact point where switch(es) C is/are interlocked on the way up.

4.1.2. Checking/Adjusting the set point

4. Slowly raise the pressure, and then slowly lower it again. Measure the lower and upper triggering thresholds.
5. Refine the settings using adjustment screw VG (Lower and Upper threshold control).
6. Disconnect the instrument from the bench.
7. For the F series (zamak housing), apply a seal to adjustment screw VG using a Georgin seal kit. For the FP (polyester housing) and FX (stainless steel housing) series instruments, screw the protecting cap and seal the whole.
8. Close the cover and tighten the four captive screws (torque: 1.2 N·m).

4.2. Procedure A2: Diaphragm-actuated differential instrument

For reasons related to production and metrology, low- and medium-pressure differential instruments are adjusted relative to each other, with the LP chamber vented to atmosphere.

The procedure is identical to the procedure described in the previous point (A.1. Single instrument).

The HP chamber is connected to the pressure bench, and the LP remains at atmospheric pressure.

4.3. Procedure A3: Bellows-actuated differential instrument

Example: Lower threshold set to 1 bar falling with 10 bar static pressure.

4.3.1. Setting the lower threshold

1. Go up to the desired static pressure in both chambers (10 bar), and stabilise.
2. Isolate both chambers.
3. Create a pressure differential in favour of the HP chamber equal to the desired threshold value "1 bar" (HP=10 bar, LP=9 bar).
4. Using set point adjustment screw VG, decompress range spring RG until the exact point when switch(es) C is/are interlocked on the way down.

4.3.2. Checking/Adjusting the set points

5. Repeat operations 1 and 2, and then slowly pressurise and depressurise the HP chamber to measure the changeover value of the switch(es) on the way down.
6. Refine the setting using adjustment screw VG (Lower and Upper threshold control).
7. Disconnect the instrument from the bench.
8. For the F series (zamak housing), apply a seal to adjustment screw VG using a GeorGIN seal kit. For the FP (polyester housing) and FX (stainless steel housing) series instruments, screw the protecting cap and seal the whole.
9. Close the cover and tighten the four captive screws (torque: 1.2 N·m).

5. Type B adjustment: adjustable dead band instrument

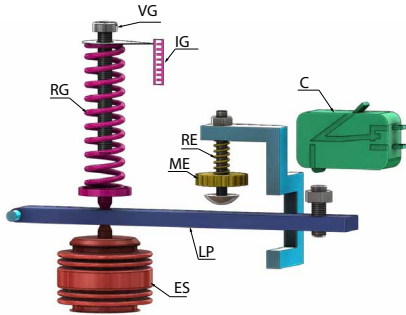
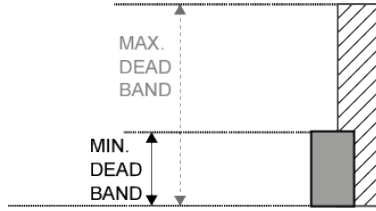

- VG: Range adjustment screw
- RG: Range spring
- IG: Range index
- RE: Dead band adjustment and offset spring
- ME: Dead band adjustment and offset knob
- ES: Sensing element
- LP: Flexible arm
- C: Switch

5.1. Procedure B1: Single instrument

Example: 2 mbar falling and 6 mbar rising.

5.1.1. Setting the lower threshold

1. Inhibit the dead band spring (RE) by fully tightening the knob (ME).
2. Raise the pressure to the lower threshold (2 mbar), and stabilise it.
3. Using set point adjustment screw VG, relax range spring RG until the point when switch C is interlocked on the way down.

5.1.2. Setting the upper threshold

4. Keep the pressure stable at 2 mbar.
5. Fully compress spring RE by actuating knob ME (anticlockwise).
6. Raise the pressure to the upper threshold (6 mbar) and stabilise it.
7. Using dead band adjustment knob ME, relax dead band spring RE until the exact point when switch(es) C is/are triggered on the way up.

5.1.3. Checking/Adjusting the set points

8. Slowly raise the pressure, and then slowly lower it again. Measure the lower and upper triggering thresholds.
9. Refine the settings using screw VG (Low threshold control) and knob ME (High threshold offset).
10. Disconnect the instrument from the bench.
11. For the F series (zamak housing), apply a seal to adjustment screw VG using a Georgin seal kit.
For the FP (polyester housing) and FX (stainless steel housing) series instruments, screw the protecting cap and seal the whole.
12. Close the cover and tighten the four captive screws (torque: 1.2 N·m).

5.2. Procedure B2: Diaphragm-actuated differential instrument

For reasons related to production and metrology, low- and medium-pressure differential instruments are adjusted relative to each other, with the LP chamber vented to atmosphere.

The procedure is identical to the procedure described in the previous point (B.1. Single instrument).

The HP chamber is connected to the pressure bench, and the LP remains at atmospheric pressure.

5.3. Procedure B3: Bellows-actuated differential instrument

Example: Set the low threshold to 1 bar downwards and the high threshold to 3 bar upwards, and static pressure 10 bar.

5.3.1. Setting the lower threshold

1. Inhibit the dead band spring (RE) by fully tightening the knob (ME).
2. Go up to the desired static pressure in both chamber (10 bars), and stabilise
3. Isolate both chambers.
4. Create a pressure differential in favour of the HP chamber equal to the desired low threshold value "1 bar" (e.g., HP=10 bar, LP=9 bar).
5. Using set point adjustment screw VG, relax range spring RG until the exact point when switch(es) C is/are interlocked on the way down.

5.3.2. Setting the upper threshold

6. Return to the desired static pressure in both chambers (10 bar), and stabilise.
7. Isolate both chambers.
8. Fully compress spring RE.
9. Create a pressure differential in favour of the HP chamber equal to the desired high threshold value "3 bar" (HP=10 bar, LP=7 bar).
10. Using dead band adjustment knob ME, relax dead band spring RE until the exact point when switch(es) C is/are triggered on the way up.

5.3.3. Checking/Adjusting the set points

11. Repeat operations 2 and 3, and then slowly pressurise and depressurise the HP chamber to measure the changeover values of the switch(es) on the way up and the way down.
12. Refine the settings using the threshold adjustment screw (VG = Lower threshold and ME = Upper threshold).
13. Disconnect the instrument from the bench.
14. For the F series (zamak housing), apply a seal to adjustment screw VG using a GeorGIN seal kit.
For the FP (polyester housing) and FX (stainless steel housing) series instruments, screw the protecting cap and seal the whole.
15. Close the cover and tighten the four captive screws (torque: 1.2 N·m).

6. Type C adjustment: instrument with two offset switches

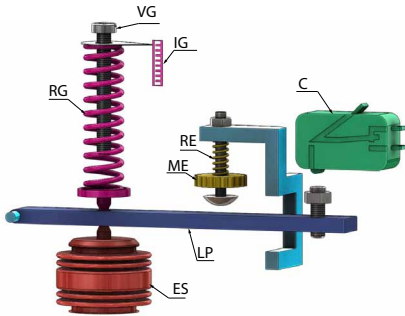
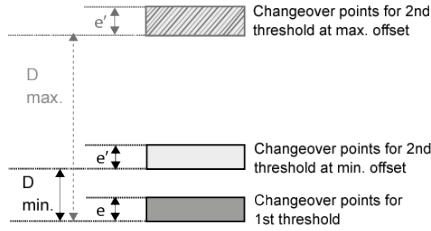

VG: Range adjustment screw

RG: Range spring

IG: Range index

RE: Dead band adjustment and offset spring

ME: Dead band adjustment and offset knob

ES: Sensing element

LP: Flexible arm

C: Switch

6.1. Procedure C1 : Single instrument

Example: Set the first threshold to 5 bar downwards and the second threshold to 6 bar upwards.

6.1.1. Set the first LP switch threshold.

1. Inhibit the dead band spring (RE) by fully tightening the knob (ME)
2. Raise the pressure to the first threshold (5 bar) and stabilise it.
3. Using set point adjustment screw VG, relax range spring RG until the point when the first threshold (LP switch) is triggered on the way down.

6.1.2. Set the second HP switch threshold.

4. Raise the pressure to the second threshold (6 bar) and stabilise it.
5. Fully compress spring RE.
6. Using dead band adjustment knob ME, relax dead band spring RE until the exact point when the second threshold (HP switch) is triggered on the way up.

6.1.3. Checking/adjusting thresholds

7. Slowly raise the pressure, and then slowly lower it again. Measure the desired thresholds.
8. Refine the settings using screws VG (1st threshold, LP control) and ME (2nd threshold, HP control).
9. Disconnect the instrument from the bench.
10. For the F series (zamak housing), apply a seal to adjustment screw VG using a Georgin seal kit.
For the FP (polyester housing) and FX (stainless steel housing) series instruments, screw the protecting cap and seal the whole.
11. Close the cover and tighten the four captive screws (torque: 1.2 N·m).

6.2. Procedure C2: Diaphragm-actuated differential instrument

For reasons related to production and metrology, low- and medium-pressure differential instruments are adjusted relative to each other, with the LP chamber vented to atmosphere.

The procedure is identical to the procedure described in the previous point (C.1. single instrument).

The HP chamber is connected to the pressure bench, and the LP remains at atmospheric pressure.

6.3. Procedure C3: Bellows-actuated differential instrument

Example: Set the first threshold to 1 bar downwards and the second threshold to 5 bar upwards, with static pressure 10 bar.

6.3.1. Set the first LP switch threshold.

1. Inhibit the dead band spring (RE) by fully tightening the knob (ME)
2. Go up to the desired static pressure in both chamber (10 bars), and stabilise.
3. Isolate both chambers.
4. Create a pressure differential in favour of the HP chamber corresponding to lowering the first required threshold "1 bar" (HP=10 bar, LP=9 bar).
5. Using set point adjustment screw VG, relax range spring RG until the exact point when the first threshold (LP switches) is triggered on the way down.

6.3.2. Set the second HP switch threshold.

6. Return to the desired static pressure in both chambers (10 bar), and stabilise.
7. Isolate both chambers.
8. Fully compress spring RE.
9. Create a pressure differential in favour of the HP chamber equal to the second desired high threshold value "5 bar" (HP=10 bar, LP=5 bar).
10. Using dead band adjustment knob ME, relax dead band spring RE until the exact point when the second threshold is triggered on the way up (HP switch).

6.3.3. Checking/adjusting thresholds

11. Repeat operations 2 and 3, and then slowly pressurise and depressurise the HP chamber to measure the changeover values of the switches on the way up and the way down.
12. Refine the settings using the threshold adjustment screw (RG = 1st threshold and RE = 2nd threshold).
13. Disconnect the instrument from the bench.
14. For the F series (zamak housing), apply a seal to adjustment screw VG using a Georgin seal kit.
For the FP (polyester housing) and FX (stainless steel housing) series instruments, screw the protecting cap and seal the whole.
15. Close the cover and tighten the four captive screws (torque: 1.2 N·m).

VI. Wiring

1. The electrical switch

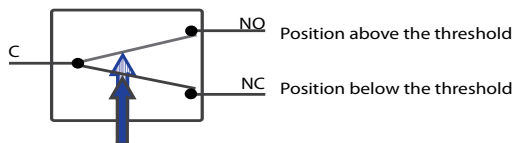

Resting state of the switch(es) :

At rest, contact is established between C-NC. According to the type of action (opening or closing of the electrical circuit), make the electrical connection on the terminal block between C-NC or C-NO.

2. Cable entries

The instruments (except explosion-proof housings) are supplied with one or two cable glands. Refer to the delivery note of the product for the corresponding diameter of the cable.

Other cable gland models are available on request.

The instrument can also be supplied without cable inlets. In that case, the instrument is supplied with an M16x1.5 thread for the F serie (zamak housing) or an M20x1.5 thread for the FP (polyester housing) and FX (stainless steel housing) series as standard.

The cable gland must be mounted according to the attached datasheet.

Explosion-proof housings: the housing is supplied as standard with a type 3/4" NPT cable inlet. Cable glands are available as an option. The choice of cable gland directly affects the certification, and could lead to the equipment being declassified. Refer to the ATEX instruction sheet. The cable gland must be mounted according to the attached datasheet. Apply graphite grease on the cable entry threading before tightening the cable gland.

Ensure that the cable gland has been tightened sufficiently, and add 'drip protection' to the cable in order to preserve the instrument's IP level.

3. Internal terminal blocks

The terminal blocks are designed for the following maximum wire size: 2.5 mm² for standard models and 1.5 mm² for ATEX models.

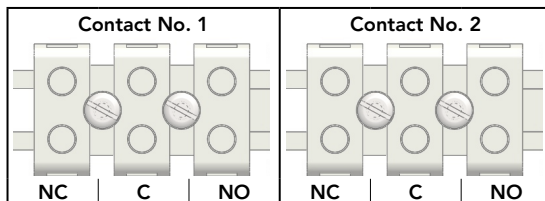

Standard contacts:

4 / 6 / 10 / 16 (D) (T)	blue	red	white	blue	red	white
34 / 54 (D) (T)	3	2	1	3	2	1

Nitrogen sealed contacts

96 (D)	green	white	red	•	•	•
106 / 116 (D)	green	white	red	green	white	red

Explosion-proof contacts

60 (D) / 160 (D) / 170 (D)	2	1	4	2	1	4
62 (D) / 162 (D) / 172 (D)						

Cable outlet explosion-proof contacts

60C / 160C / 170C	green	white	brown	green	white	brown
62C / 162C / 172C	grey	black	brown	grey	black	brown

For specific electrical connections, refer to the associated technical drawings.

Housing closure (except explosion-proof housings):

To preserve the instrument's protection (IP) class, the cover must be closed and tightened to the following torque : 1.2 N·m.

4. Breaking capacity (resistive circuits)

4.1. Breaking capacities

Contact No.	AC		DC	
	Current	Voltage	Current	Voltage
4/6/34/54	10A	240V	0.5A	110V
10/30/50	5A	240V	0.5A	130V
16/36/56	2A	240V	1A	130V
96/106/116	2.5A	240V	1A	130V
4D/6D/34D/54D	-	-	1mA/100mA	4V/30V
10D/30D/50D	-	-	50mA	30V
16D/36D/56D/60D/62D	-	-	10mA / 100mA	6V / 24V
62/62C/162/162C/172/172C	5A	240V	0.4A	250V
60/60C/160C/170C (F and FP Series)	7A	240V	0.25A	250V
60/160/170 (FX Series)	5A	240V	0.4A	250V
18D/20D	-	-	10mA / 50mA	6V / 30V

IMPORTANT

Intrinsic Safety certified instruments (Ex ia) are equipped with gold-plated contacts. These instruments must be interfaced via an intrinsically safe relay. Georgin recommends the RDN model - see fc-rdn-fren on www.georgin.com.

The explosion proof switches with cable output must be imperatively connected to an approved terminal block and a junction box.

4.2. Breaking capacity limits

Gold-plated contacts:

Minimum threshold: 10 mA - 6 Vdc

Maximum threshold: 100 mA - 24 Vdc

Never operate or test the instrument above the maximum threshold.

Standard contacts: Never use below 100 mA - 24 VAC.

5. The pneumatic switch

Labelling of the cell connections:

- Connection:
- A:** Power supply
 - U:** Use
 - E:** Exhaust

NO operation

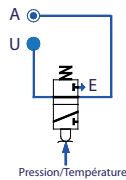

NC operation

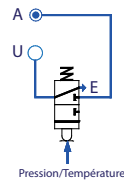

For some models, exhaust is via open cable gland or screw terminal (mandatory for ATEX models).

The control pressure applied to the unit affects the dead band: the lower the supply pressure, the smaller the dead band, and vice-versa.

VII. Maintenance

1. Inspection frequency

Inspection frequency depends on several criteria:

- » The mechanical and/or electrical working life of the microswitch
- » The mechanical working life of the sensing element
- » Frequency and conditions of operation of the instrument

Georgin's standard* recommendation is to proceed as indicated:

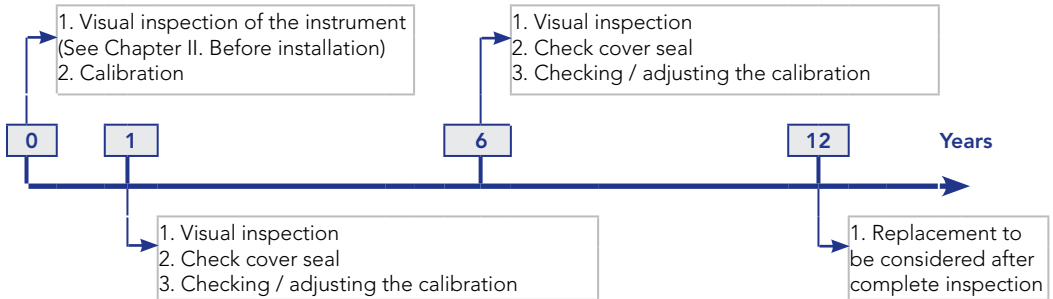

» Year 0 :

1. Check that the paint has not been damaged, and check that there are no signs of deformation or impact on the housing.
2. Calibration :
If the instrument is supplied adjusted: Check that the calibration is compliant, and readjust if necessary.
If the instrument is supplied unadjusted: Calibrate it according to the procedures given in this manual.

» Year 1 :

After one year of standard operation, the mechanism can be considered to be run in. The following points must therefore be checked:

1. Check that the paint has not been damaged, and check that there are no signs of deformation or impact on the housing.
2. Open the cover and check that the cover seal is not damaged (cracks, etc.)
3. Check the calibration and adjust if necessary (applying the procedures given in this manual).

» Year 6 :

After six years of standard operation, perform another inspection to ensure that the instrument is ageing well.

1. Check that the paint has not been damaged, and check that there are no signs of deformation or impact on the housing.
2. Open the cover and check that the cover seal is not damaged (cracks, etc.)
3. Check the calibration and adjust if necessary (applying the procedures given in this manual).

» Year 12 :

After 12 years in standard operation, Georgin recommends sending the instrument to our After Sale Service department for diagnosis. This may lead to some components being replaced or the instrument being scrapped.

After 12 years of operation, an annual inspection must be performed.

Note: Beyond 20 years of operation, no further repairs will be carried out. The instrument will always be scrapped in the event of failure.

*In view of the many and varied possible uses on industrial sites, the maintenance frequency must be increased in case of heavy-duty operation or harsh conditions.

For example:

- High rate > 4 cycles/minute
- Corrosive or crystalline fluid or environments



Instruments in safety roles must be inspected annually or according to the constraints of the associated Instrumented Safety Function.

2. Precautions to take during maintenance

The instrument must be disassembled WHEN DISCONNECTED FROM POWER, using an appropriate spanner for the fitting.

GEORGIN guarantees the qualification of the equipment that leaves the factory. Any operation performed on the equipment other than adjusting the instrument releases GEORGIN from all liability in the event of failure.

In the event you suspect a failure or permanent fault, return the equipment to our offices or our representatives, who are the only maintenance providers certified to perform expert assessments or repairs. Any equipment returned MUST be accompanied by an After Sale Service return form. This can be obtained from www.georgin.com (look under "download/After Sale Service") and must be duly completed and signed.



Safety for Industrial Process



"Imagined, designed and made in France"

Régulateurs GEORGIN

France

14-16, rue Pierre Sépard - BP 107 - 92323 CHATILLON Cedex France
Tel.: +33 (0)1 46 12 60 00 - Fax: +33 (0)1 47 35 93 98 - Email: regulateurs@georgin.com

Belgium

Temselaan 5 - 1st floor - 1853 STROMBEEK-BEVER
Tel: +32 (0)2 735 54 75 - Fax: +32 (0)2 735 16 79 - Email: info@georgin.be

www.georgin.com